

WiFi & RF 5 in 1 LED Controller

Model No.: WT5

Tuya APP cloud control/Voice control/5 Channels/1-5 color/DC power socket input/Wireless remote control

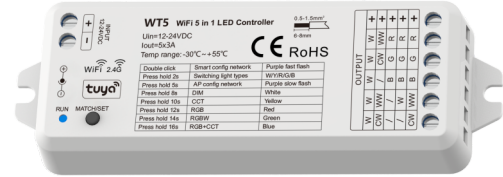

FC CE RoHS EMC LVD RED

Features

- 5 in 1 function, used for control RGB, RGBW, RGB+CCT, color temperature or single color LED strip.
- DC power socket input and 5 channel constant voltage output.
- Tuya APP cloud control, support on/off, RGB color, color temperature and brightness adjust, delay turn on/off light, timer run, scene edit and music play function.
- Voice control, support amazon ECHO and TmallGenie smart speaker.
- Match with RF 2.4G remote control optional.
- User need set light type by press key before Tuya APP network connection and match RF remote of the same light type.
- Each WT5 controller can also work as WiFi-RF converter, then use Tuya APP to control one or more RF LED controller or RF LED dimming driver synchronously.
- Light on/off fade time 3s selectable.

Technical Parameters

Input and Output	
Input voltage	12-24VDC
Input current	1.5.5A
Output voltage	5 x (12-24)VDC
Output current	5CH, 3A/CH
Output power	5 x (36-72)W
Output type	Constant voltage

Dimming data	
Input signal	Tuya APP + RF 2.4GHz
Control distance	30m(Barrier-free space)
Dimming gray scale	4096 (2^12) levels
Dimming range	0-100%
Dimming curve	Logarithmic
PWM Frequency	1000Hz (default)

Safety and EMC	
EMC standard (EMC)	ETSI EN 301 489-1 V2.2.3 ETSI EN 301 489-17 V3.2.4
Safety standard(LVD)	EN 62368-1:2020+A1 1:2020
Radio Equipment(RE)	ETSI EN 300 328 V2.2.2
Certification	CE, EMC, LVD, RED

Environment	
Operation temperature	Ta: -30°C ~ +55°C
Case temperature (Max.)	Tc: +85°C
IP rating	IP20

Warranty and Protection	
Warranty	5 years
Protection	Reverse polarity Over-heat Short circuit

Mechanical Structures and Installations

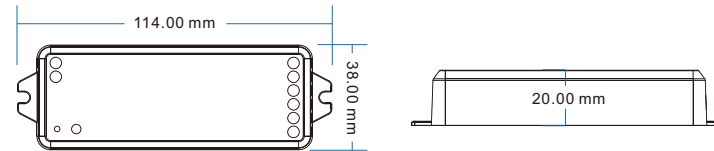
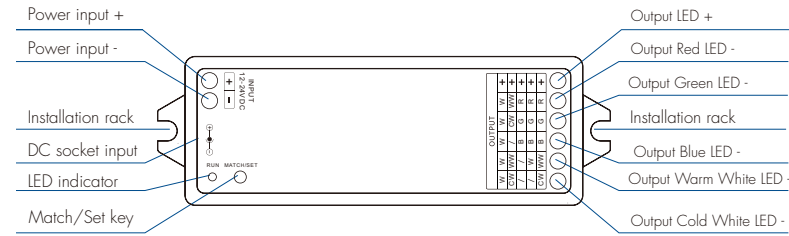

System wiring

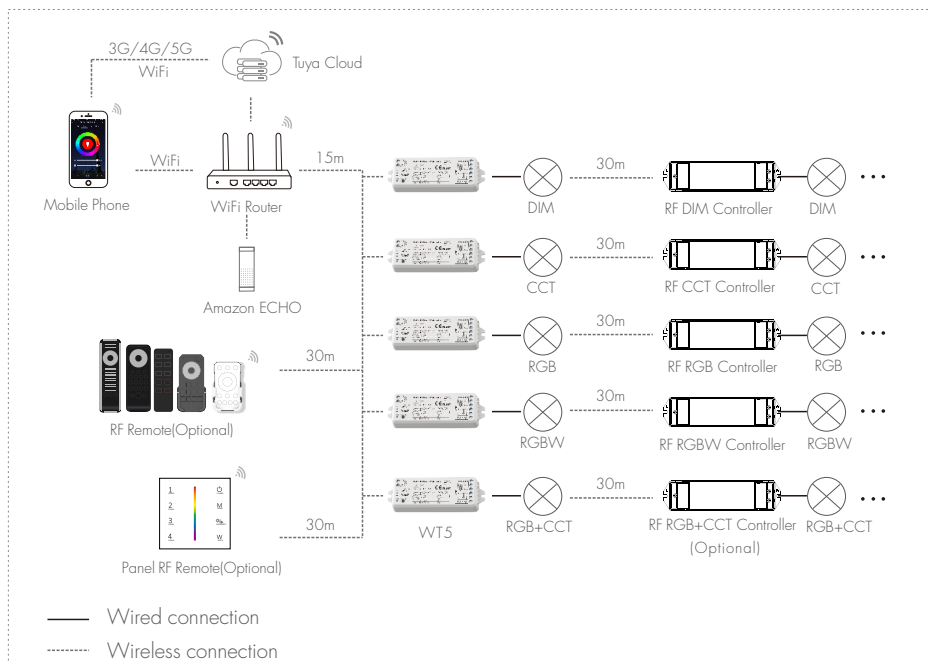

Note:

1. The above distance is measured in spacious (no obstacle) environment, Please refer to the actual test distance before installation.
2. Please check if the WiFi router net in 2.4G band, the 5G band is not available, and do not hide your router network.
3. Please keep the distance between WT5 devices and router close, and check the WiFi signals.

Wiring Diagram

• For RGB+CCT

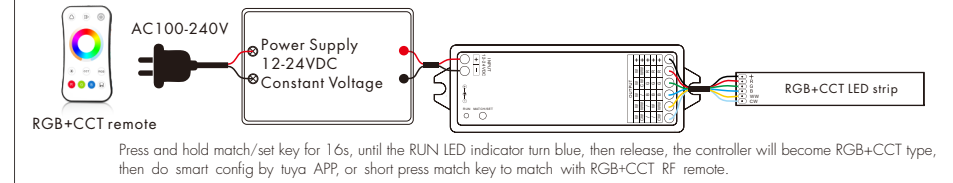

• For RGBW

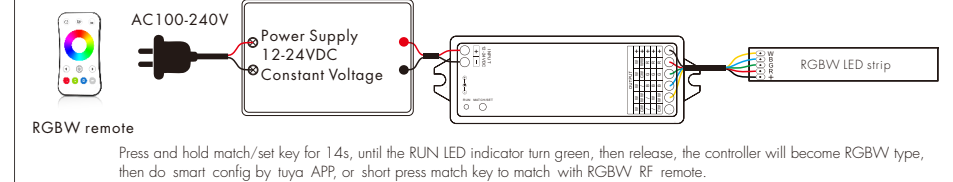

• For RGB

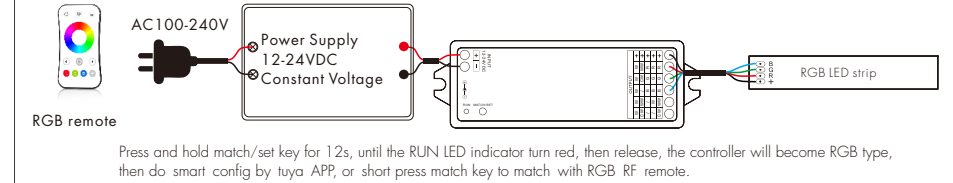

• For dual color CCT

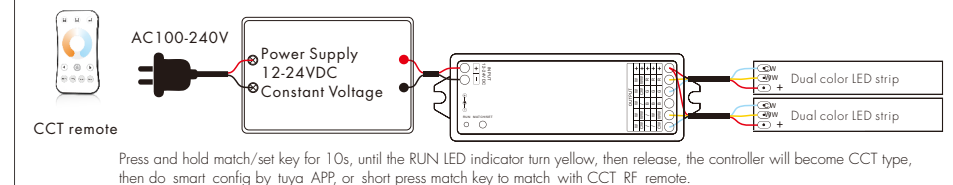

• For single color

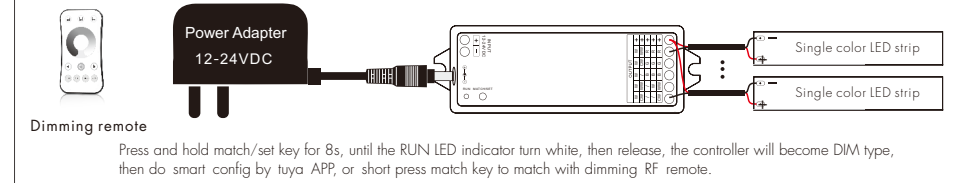

- Note:
1. User can connect constant voltage power supply or power adapter as power input.
 2. Press and hold Match/Set key for 2s, switch 5 kinds light type in sequence.
 3. For RGB+CCT or CCT light type, continuous power on and off will change 3 levels color temperature (WW, NW and CW) in sequence.
 4. Switch off the power, then switch on power, repeat again. Immediately short press match key 3 times, the light on/off time will change between 3s and 0.5s.

Tuya APP network connection

Push twice Match/Set key fastly, or when press and hold Match/Set key for 8-10s to set 5 kinds light type:
Clear previous network connection, enter Smart config mode, the purple LED indicator flash fastly, the output LED will flash 10 times.

Press and hold Match/Set key for 2s:
Switch 5 kinds light type in sequence, notice this operation does not automatically clear previous network connection.

Press and hold Match/Set key for 5s:
Clear previous network connection, enter AP config mode, the purple LED indicator flash slowly.
If smart config failed, please try AP config.

Repeat power on and off for 5 consecutive times, also clear previous network connection, enter Smart config mode, the output LED will flash 10 times.

If Tuya APP network connection succeed, the RUN LED indicator will stop flash purple, and turn corresponding light type color (White: DIM, Yellow: CCT, Red: RGB, Green: RGBW, Blue: RGB+CCT).
and in Tuya APP, you can find RGB+CCT device (or other DIM, CCT, RGB or RGBW).

Tuya APP interface

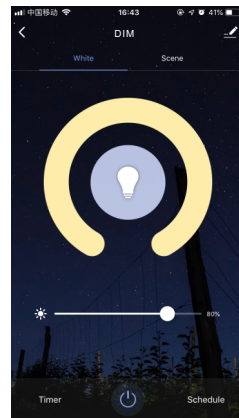

White interface

For DIM type:
Touch brightness slide to adjust brightness.

For RGB type:
Touch brightness slide, get RGB mixed white firstly, then to adjust white brightness.

For RGBW type:
Touch brightness slide, adjust white channel brightness.

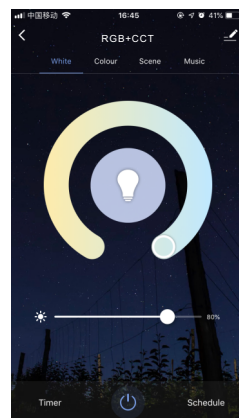

Color temperature interface

For CCT type:
Touch color wheel to adjust color temperature.
Touch brightness slide to adjust brightness.

For RGB+CCT type:
Touch color wheel to adjust color temperature, RGB will turn off automatically.
Touch brightness slide to adjust white brightness.

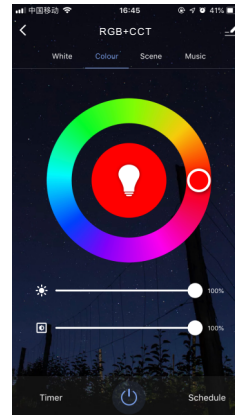

Colour interface

For RGB or RGBW type:
Touch color wheel to adjust static RGB color.
Touch brightness slide to adjust color brightness.
Touch saturation slide to adjust color saturation, namely gradient from the current color to white (RGB mixed).

For RGB+CCT type:
Touch color wheel to adjust static RGB color, WW/CW will turn off automatically.
Touch brightness slide to adjust color brightness.
Touch saturation slide to adjust color saturation, namely gradient from the current color to white (RGB mixed).



Scene interface

The 1-4 scene is static color for all light type.
the inner color of these scene can be editable.

The 5-8 scene is dynamic mode for RGB, RGBW, RGB+CCT type,
such as green fade in and fade out, RGB jump, 6 color jump, 6 color smooth.

Music, Timer, Schedule

The music play can use smart phone music player or micro-phone as music signal input.

The Timer key can turn on or turn off light in the next 24 hours.

The Schedule key can add multiple timers to turn on or turn off light according to different time periods.

WT5 match remote control (Optional)

End user can choose the suitable match/delete ways. Two options are offered for selection:

Use the WT5's Match key

Match:
Short press match key of WT5,
immediately press on/off key (single zone remote)
or zone key (multiple zone remote) on the remote.
The LED indicator fast flash a few times
means match is successful.

Delete:
Press and hold match key of WT5 for 20s,
The LED indicator fast flash a few times
means all matched remotes were deleted.

Use Power Restart

Match:
Switch off the power of WT5, then switch on power, repeat again.
Immediately short press on/off key (single zone remote)
or zone key (multiple zone remote) 3 times on the remote.
The light blinks 3 times means match is successful.

Delete:
Switch off the power of WT5, then switch on power, repeat again.
Immediately short press on/off key (single zone remote)
or zone key (multiple zone remote) 5 times on the remote.
The light blinks 5 times means all matched remotes were deleted.

WT5 work as WiFi-RF converter to match RF LED controller or dimming driver

End user can choose the suitable match/delete ways. Two options are offered for selection:

Use the controller's Match key

Match:
Short press match key of the controller,
immediately press on/off key on the Tuya APP.
The LED indicator fast flash a few times
means match is successful.

Delete:
Press and hold match key of the controller for 5s,
The LED indicator fast flash a few times
means match was deleted.

Use Power Restart

Match:
Switch off the power of the controller, then switch on power,
repeat again.
Immediately short press on/off key 3 times on the Tuya APP.
The light blinks 3 times means match is successful.

Delete:
Switch off the power of the controller, then switch on power,
repeat again.
Immediately short press on/off key 5 times on the Tuya APP.
The light blinks 5 times means match was deleted.

Dynamic mode list

For RGB/RGBW:

No.	Name	No.	Name
1	RGB jump	6	RGB fade in and out
2	RGB smooth	7	Red fade in and out
3	6 color jump	8	Green fade in and out
4	6 color smooth	9	Blue fade in and out
5	Yellow cyan purple smooth	10	White fade in and out

For RGB+CCT:

No.	Name	No.	Name
1	RGB jump	6	RGB fade in and out
2	RGB smooth	7	Red fade in and out
3	6 color jump	8	Green fade in and out
4	6 color smooth	9	Blue fade in and out
5	Color temperature smooth	10	White fade in and out